

HELI
LIFTING THE FUTURE

1-3.5t
H3 Series Internal Combustion
Counterbalanced Forklift Truck (Euro Stage V)

STAGE V



www.heliforklift.net



ANHUI HELI CO., LTD.

ADD: NO.668 Fangxing Street, Economical Development Zone, Hefei, P.R.China
TEL: (86 551) 63639068(America); 63639258(Europe); 63639358(Asia);
63662105(Africa & Middle East); 63639530(Key Accounts Division);
63662105(Wheel loader)

FAX: (86 551) 63639966 WEBSITE: <http://www.heliforklift.net>
Email: hel@helichina.net

* Our products are subject to improvements and changes without notice.

Catalog No. 201009 FOKELI Print



HIGH QUALITY PRODUCT

H3 series is proudly launched adhering to the principle of repaying the society with high quality product and vision of being century-old enterprise. To HELI, the H3 series is the culmination and milestone in pursuit of mastery in the development and manufacture of forklift over the years.

Elaborately built H3 series will provide you high level driving experience with environment friendliness, outstanding comfort, safety and reliability, easy maintenance and excellent working efficiency.

Engine Model:

XINCHAI 3E22YG51(Diesel)

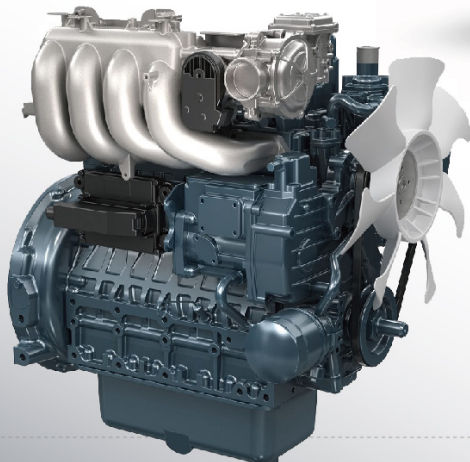
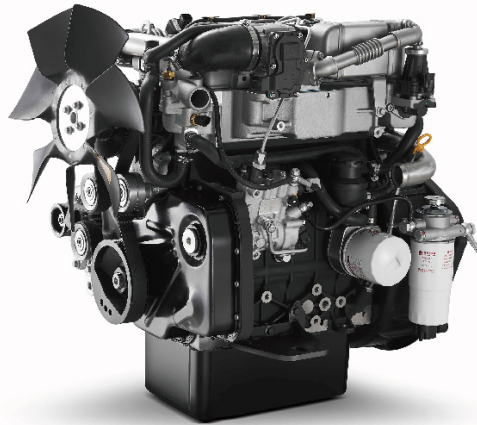

Engine Model:

KUBOTA V2403(Diesel)
KUBOTA WG2503(GAS/LPG)



The whole machine adopts the engine conforming to the EU StageV and the American environmental protection standard;

- The diesel engine adopts KUBOTA V2403 EU StageV and XINCHAI 3E22YG51 EU StageV electronic high pressure common rail engine and DOC + DPF tail gas treatment technology.
- Single/Dual fuel using KUBOTA WG2503 electronic high pressure common rail engine, using three catalytic tail gas treatment technology.

Note: DOC — Diesel Oxidation Catalyst. DPF — Diesel Particulate Filters

H3

STAGE V

Safety and reliability

HELI keeps improving truck safety and reliability to ensure the safety of people, machine and goods.



■ ratchet parking brake

■ automobile type oil adding cap structure ■ double-lip elastic sealing gasket

Enhanced Operator Presence System with comprehensive security upgrade

■ Walking on site induction safety system

When the machine is running, the operator will suddenly leave the correct operating position without releasing the accelerator pedal, and the power will be cut off to protect the safety of running.

■ LHS (Load Handling System) on site induction safety system and reset control system

When the operator leaves or returns to the correct operating position without loosening the LHS control device, the operation brought by the LHS operation will be suspended and will not occur automatically, so as to protect the LHS operation safety.

■ LHS (Load Handling System) static control system

When the LHS control device is operated and the engine is started, the operation brought by LHS control will not happen automatically after the engine is started. Only when the LHS control device is reset and then operated can the operation continue.

■ Non-parking security alarm system

When the forklift is not powered off and the driver is not using the parking brake, an audible warning is used to alert the driver.

Improved cooling performance

- The hot air reflow isolating device, aluminum plate-fin type radiator, 60mm backward muffler and optimized thermal dissipation duct improve cooling ability and ensure engine work reliability to meet the requirements of working under harsh and high temperature environment better.
- The hydraulic system adopts high efficiency and low loss technology, comprehensively optimizes the hydraulic piping system and sealing form, and further reduces the pressure loss, hydraulic oil temperature and sealing reliability in the hydraulic system.

Driver restraint warning system

- The vehicle is equipped with driver's safety belt restraint warning system, which makes driving safer.

Key parts

- The optimal design of key parts like frame, mast and overhead guard improve the whole truck's safety and reliability.

Fully-closed panel-mounted cab

- Fully-closed panel-mounted cab with high strength ensures the safety of people and machine fully.

Casting axle

- The key rotation parts are protected from water and dust to extend their maintenance period. With the using of casting axle, the bearing load carrying ability is improved and the truck structure is simple and reliable. The service life is prolonged.



Easy maintenance

Easy maintenance which is good for maintaining the optimal condition of key parts and completed truck and ensures safety and work efficiency is the necessary character of a good product.

Large engine hood opening angle

- Engine hood lock integrated on the hood is convenient for opening and close during maintenance.
- The gas spring has optimized arrangement, improved load carrying ability, opening angle, prolonged gas spring service life and improved opening comfort. 80° engine hood opening angle offers wide operation space for check and maintenance.

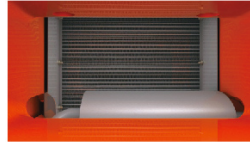

■ compositional radiator heat flow baffle



■ brake liquid reservoir

DPF (Diesel Particulate Filters) automatic regeneration

- Euro 5 diesel-powered model is equipped with DPF automatic regeneration function, and the instrument is equipped with DPF blocking quantity display function (equipped with diesel vehicle), which is convenient for maintenance; When running the automatic regeneration program, the engine provides 100% power output. The DPF regeneration program can be interrupted at any time. DPF cleaning interval increased from 3000 hours to 6000 hours.

Low after-sales maintenance cost

- Equipped with Euro V diesel, liquefied gas, dual fuel power configuration to meet the needs of different users.
- Based on the same platform of a variety of fuel (diesel / liquefied gas) configuration scheme, the main parts of the general, low after-sales maintenance cost is low.



■ mast pipeline



Excellent working efficiency

With high efficiency, the truck perfectly guarantees the material handling work at port, dock, and railway station. It can meet the requirements for various kinds of complicated work conditions.

Quick responding steering wheel

- With 100% pivot steering and returning, the truck has good maneuverability in narrow space.
- The truck has small turning radius, easy steering, good gradeability and flexible maneuverability.

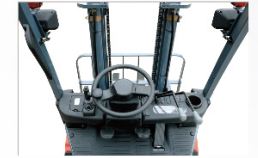

Needs of low-temperature areas

- The prototype was tested at -25°C in the cold storage laboratory to meet the demand for use at this temperature.

Diesel products with large capacity batteries

- Euro V diesel-powered models use large capacity batteries, vehicle start, electricity is more secure.



Environment-friendliness

Clean and environment-friendly power meeting international emission standard is assembled on the H3 series to reduce harmful emissions and be environment-friendly. Meanwhile, H3 series effectively reduce truck vibration and noise.

Suspension cab

- Cushion connection between the frame and cab and wholly suspension cab absorb whole truck's vibration effectively. Fully-closed panel-mounted cab isolates the noise.

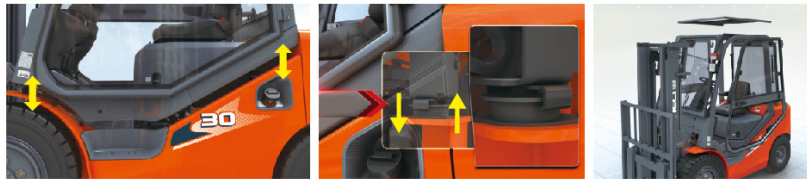

- suspension cab
- damping support of the suspension cab
- panel-mounted cab

Mast lowering buffering device

- It reduces shock and vibration to the mast and avoids crash noise caused by goods falling to the ground.



- lowering buffering device

Outstanding comfort

Ergonomic designs, optimized operating device structure and layout improve driving experience and ensure long hours of efficient operation.

Enlarged operating space

- Tilting cylinder located below the floor board, 30mm widened low anti-skidded step and 45% enlarged operation space at foot provide comfort entry, exit and operation.
- 80mm heightened overhead guard and large arc shape of the overhead guard's front leg enlarge operating space and reduce operating fatigue.



- hidden tilting cylinder
- comfortable space
- comfortable space

Outstanding visibility

- With three-stage free lift mast, front view width is increased by 30mm; with 15mm lowered instrument panel, the visibility of fork and goods is increased by 20mm. CAE optimized counter weight structure improve rear view.



- visibility at the fork tip and goods 20mm increased
- front view 30mm enlarged

LED combined instrument

- With the clear displaying and right installment of the instrument, the operator can know the truck information in time.

Rear assist handle (optional)

- The assist grip with a horn enhances comfort by offering easy horn operation while travelling in reverse.



Manufacturer and technical parameters

Manufacturer and technical parameters								
Character								
1.01	Manufacturer	HELI						
1.02	Model	CPCD10/CP(Q)YD10	CPCD15/CP(Q)YD15	CPCD18/CP(Q)YD18				
1.03	Rated capacity	kg	1000	1500	1750			
1.04	Load center	mm	500					
1.05	Operation mode	Seat-type						
Size								
2.01	Max. lifting height	H	mm					3000
2.02	Mast overall height (Fork to the ground and mast be vertical)	H1	mm	1995	1995	1995		
2.03	Max. fork lifting height (With backrest)	H2	mm	4014				
2.04	Free lift height	H3	mm	152	155	155		
2.05	Overall height (Overhead guard)	H4	mm	2140				
2.06	Min. ground clearance (At the mast)	H5	mm	110				
2.07	Distance from the surface of the seat to the overhead guard	H6	mm	1018				
2.08	Overall length (With fork / Without fork)	(L/L')	mm	3197/2277	3201/2281	3219/2299		
2.09	Wheel base	L1	mm	1450				
2.10	Overall width	W1	mm	1070				
2.11	Tread (Front tread / Rear tread)	(W3/W2)	mm	902/928	902/928	932/928		
2.12	Fork adjustable range (The external of the fork)(Max./Min.)	W5	mm	950/200				
2.13	Min. turning radius (Exterior)	r	mm	1875	1910	1930		
2.14	Min. right angle aisle width	Ra	mm	2011	2016	2035		
2.15	Min. right angle stacking aisle width	Ast	mm	3576	3584	3603		
2.16	Mast tilting angle	α / β	deg	6/10				
2.17	Fork size	L4×W×T	mm	770×100×32	920×100×35	920×100×35		
Weight								
3.01	Total weight	kg	2540	2720	2850			
Wheel and tyre								
4.01	Tyre type (Front/Rear)	Pneumatic tyre						
4.02	Tyre size (Front/Rear)	6.50-10-10PR/5.00-8-10PR		6.50-10-10PR/5.00-8-10PR		6.50-10-10PR/5.00-8-10PR		
Performance								
Model		CP(Q)YD10	CP(Q)YD15	CP(Q)YD18	CPCD10	CPCD15	CPCD18	
Configuration number		KU1H	KU1H	KU1H	KU18H	KU18H	KU18H	
Max. drawbar pull (Loaded/Unloaded)	kN	17/7	19/7	19/7	17/7	18/7	18/7	
Max. gradeability (Loaded/Unloaded)	%	40/24	40/20	40/18	40/24	40/20	40/18	
Max. traveling speed (Loaded/Unloaded)	km/h	17/18						
Lifting speed (Loaded/Unloaded)	mm/s	610/650			550/605			
Lowing speed (Loaded/Unloaded)	mm/s	450/600						
Drive and transmission control device								
Engine model		KUBOTA WG2503			KUBOTA V2403-CE-E5B			
Engine rated power	kW/rpm	GAS: 42.8/2600, LPG: 43.5/2600			33.6/2400			
Engine rated torque	Nm/rpm	GAS: 163/1800, LPG: 173 7/1400			157.4/1500			
Engine cylinder number-borexstroke		4-88×102.4			4-87×102.4			
Engine displacement	L	2.491			2.434			
Engine type		GAS/LPG			Diesel			
Emission		EU StageV / EPA/CARB Tier3			EU StageV / EPA/CARB Tier4			
Battery (Voltage/Capacity)	V/Ah	12/60			12/95			

WIDE VIEW MAST

Mast model	Max. lifting height (mm)	Load capacity (load center 500mm)(Kg)			Mast overall height (fork to the ground) (mm)	Service weight (kg)			Mast tilting angle (°) α / β
		CPCD10 CP(Q)YD10	CPCD15 CP(Q)YD15	CPCD18 CP(Q)YD18		CPCD10 CP(Q)YD10	CPCD15 CP(Q)YD15	CPCD18 CP(Q)YD18	
M200	2000	1000	1500	1800	1495	2470	2650	2780	6°-12°
M250	2500	1000	1500	1750	1745	2510	2680	2810	6°-12°
M300	3000	1000	1500	1750	1995	2540	2720	2850	6°-12°
M330	3300	1000	1500	1750	2145	2560	2740	2870	6°-12°
M350	3500	1000	1500	1750	2245	2580	2750	2880	6°-12°
M370	3700	1000	1500	1750	2345	2590	2770	2900	6°-12°
M400	4000	1000	1500	1750	2545	2650	2830	2960	6°-12°
M425	4250	950	1400	1750	2670	2660	2840	2970	6°-6°
M450	4500	950	1300	1550	2795	2680	2860	2990	6°-6°
M500	5000	950	1400	1700	3045	2720	2900	3030	6°-6°
M550	5500	*900	*1150	*1500	3345	2790	2970	3100	*3°-6°
M600	6000	*850	*1050	*1400	3595	2820	3000	3130	*3°-6°

Note: (1) Rated capacity with (*); shows capacity with front dual tires. (2) Max. lifting height without lift-bracket: -395mm.

WIDE VIEW FULL FREE 2-STAGE MAST

Mast model	Max. lifting height (mm)	Load capacity (load center 500mm)(Kg)			Mast overall height (fork to the ground) (mm)	Free lift height (with backrest) (mm)	Service weight (kg)			Mast tilting angle (°) α / β
		CPCD10 CP(Q)YD10	CPCD15 CP(Q)YD15	CPCD18 CP(Q)YD18			CPCD10 CP(Q)YD10	CPCD15 CP(Q)YD15	CPCD18 CP(Q)YD18	
ZM200	2000	1000	1500	1800	1495	480	2500	2680	2810	6°-12°
ZM250	2500	1000	1500	1800	1745	730	2530	2710	2840	6°-12°
ZM300	3000	1000	1500	1800	1995	980	2570	2750	2880	6°-12°
ZM330	3300	1000	1500	1800	2145	1130	2590	2770	2900	6°-12°
ZM350	3500	1000	1500	1800	2245	1230	2600	2780	2910	6°-12°
ZM370	3700	1000	1500	1800	2345	1330	2620	2800	2930	6°-12°
ZM400	4000	1000	1500	1700	2545	1530	2670	2850	2980	6°-12°
ZM425	4250	*1000	*1500	*1800	2670	1655	2690	2870	3000	6°-12°
ZM450	4500	1000	1400	1600	2795	1780	2710	2890	3020	6°-12°
ZM500	5000	950	1150	1200	3045	2030	2740	2920	3050	6°-6°
ZM550	5500	*1000	*1400	*1650	3345	2330	2820	2990	3120	6°-6°
ZM600	6000	450	600	750	3595	2580	2850	3030	3160	3°-6°

Note: (1) Max. Lifting height without lift-bracket: -379mm (2) Max. Lifting height without lift-bracket: +379mm (3) Rated capacity with(*); shows capacity with front dual tires

WIDE VIEW FULL FREE 3-STAGE MAST

Mast model	Max. lifting height (mm)	Load capacity (load center 500mm)(Kg)			Mast overall height (fork to the ground) (mm)	Free lift height (with backrest) (mm)	Service weight (kg)			Mast tilting angle (°) α / β
		CPCD10 CP(Q)YD10	CPCD15 CP(Q)YD15	CPCD18 CP(Q)YD18			CPCD10 CP(Q)YD10	CPCD15 CP(Q)YD15	CPCD18 CP(Q)YD18	
ZSM360	3600	1000	1500	1800	1790	775	2680	2680	2990	6°-6°
ZSM400	4000	1000	1450	1650	1925	910	2710	2710	3020	6°-6°
ZSM430	4350	1000	1400	1600	2040	1025	2730	2730	3040	6°-6°
ZSM450	4500	1000	1350	1550	2090	1075	2740	2740	3050	6°-6°
ZSM470	4700	1000	1300	1500	2160	1145	2750	2750	3060	6°-6°
ZSM480	4800	1000	1200	1500	2190	1175	2760	2760	3070	6°-6°
ZSM500	5000	900	1100	1400	2290	1275	2780	2780	3090	6°-6°
ZSM540	5400	800	950	1200	2415	1400	2810	2810	3120	3°-6°
ZSM600	6000	*1000	*1250	*1550	2640	1625	2880	2880	3190	3°-6°

Note: (1) Max. Lifting height without lift-bracket: -484mm (2) Max. Lifting height without lift-bracket: +484mm (3) Rated capacity with(*); shows capacity with front dual tires

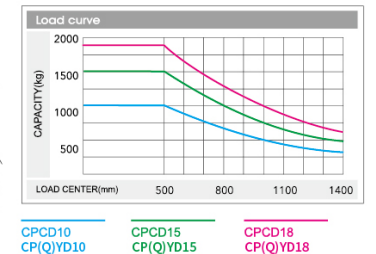
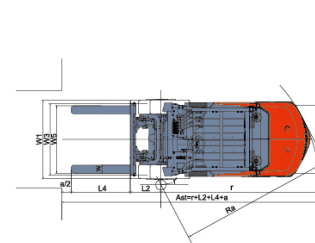
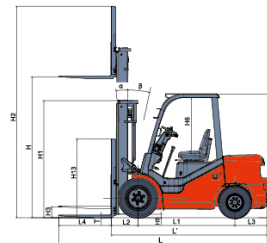

Manufacturer and technical parameters

Character		HELI					
1.01	Manufacturer						
1.02	Model	CPCD20 / CP(Q)YD20	CPCD25 / CP(Q)YD25	CPCD30 / CP(Q)YD30	CPCD35 / CP(Q)YD35		
1.03	Rated capacity	kg	2000	2500	3000	3500	
1.04	Load center	mm	500				
1.05	Operation mode	Seat-type					
Size							
2.01	Max. lifting height	H	mm	3000	3000	3000	3000
2.02	Mast overall height (Fork to the ground and mast be vertical)	H1	mm	2000	2000	2065	2180
2.03	Max. fork lifting height (With backrest)	H2	mm	4030	4030	4245	4235
2.04	Free lift height	H3	mm	165	165	160	170
2.05	Overall height (Overhead guard)	H4	mm	2150	2150	2170	2170
2.06	Min. ground clearance (At the mast)	H5	mm	115	115	135	135
2.07	Distance from the surface of the seat to the overhead guard	H6	mm	1030	1030	1030	1030
2.08	Overall length (With fork / Without fork)	(L/L')	mm	3500/2580	3708/2638	3818/2748	3836/2766
2.09	Wheel base	L1	mm	1650	1650	1700	1700
2.10	Overall width	W1	mm	1150	1150	1225	1225
2.11	Tread (Front tread / Rear tread)	(w3/w2)	mm	970/970	970/970	1000/970	1000/970
2.12	Fork adjustable range (The external of the fork) (Max. / Min.)	W5	mm	1030/244	1030/244	1060/250	1060/250
2.13	Min. turning radius (Exterior)	r	mm	2170	2240	2400	2420
2.14	Min. right angle stacking aisle width	Ra	mm	2200	2280	2380	2400
2.15	Mast tilting angle	α / β	deg	6/12	6/12	6/12	6/12
2.16	Fork size	L4×W×T	mm	920×122×40	1070×122×40	1070×125×45	1070×125×50
Weight							
3.01	Total weight	kg	3370	3740	4340	4700	
Wheel and tyre							
4.01	Tyre type (Front/Rear)	Pneumatic tyre					
4.02	Tyre size (Front/Rear)	7.00-12-12PR/ 6.00-9-10PR	7.00-12-12PR/ 6.00-9-10PR	28×9-15-14PR/ 6.50-10-10PR	28×9-15-14PR/ 6.50-10-10PR		

Performance							
Model		CP(Q)YD20	CP(Q)YD25	CPCD20	CPCD25	CPCD20	CPCD25
Configuration number		KU1H	KU1H	KU20H	KU20H	XC26H	XC26H
Max.drawbar pull (Loaded/Un loaded)	kN	24/13	24/14	18/13	19/13	27/11	27/13
Max.Gradeability (Loaded/Unloaded)	%	30/26	29/22	32/25	29/23	51/33	48/24
Max.traveling speed (Loaded/Unloaded)	km/h	17/18	17/18	17/17	17/17	17/18	17/18
Lifting Speed (Loaded/Unloaded)	mm/s	535/600	535/600	570/585	570/585	530/540	530/540
Lowing Speed (Loaded/Unloaded)	mm/s	450/500	450/500	450/500	450/500	450/500	450/500
Drive and transmission control device							
Engine mode		KUBOTA WG2503		KUBOTA V2403-CR-TE5B		XINCHAI 3E22YG51	
Engine rated power	kw/rpm	GAS:42.8/2600, LPG:43.5/2600		42.6/2400		44.8/2400	
Engine rated torque	Nm/rpm	GAS:163/1800, LPG:173.7/1400		195.6/1500		210/1600-1800	
Cylinder number-Bore×stroke		4-88×102.4		4-87×102.4		3-94×107	
Engine displacement	L	2.491		2.434		2.23	
Engine type		GAS/LPG		Diesel		Diesel	
Emission		EU StageV / EPA/CARB Tier3		EU StageV / EPA/CARB Tier4		EU StageV	
Battery(Voltage/Capacity)	V/Ah	12/60		12/95		12/80	

Performance							
Model		CP(Q)YD30	CP(Q)YD35	CPCD30	CPCD35	CPCD30	CPCD35
Configuration number		KU1H	KU1H	KU20H	KU20H	XC26H	XC26H
Max.drawbar pull (Loaded/Un loaded)	kN	23/15	22/16	20/14	21/15	26/15	25/15
Max.Gradeability (Loaded/Unloaded)	%	28/22	18/21	27/21	27/22	34/24	30/23
Max.traveling speed (Loaded/Unloaded)	km/h	18/19	18/19	18/19	18/19	18/18	18/18
Lifting Speed (Loaded/Unloaded)	mm/s	455/540	360/400	480/500	430/460	470/480	440/455
Lowing Speed (Loaded/Unloaded)	mm/s	450/500	350/400	450/550	450/550	450/550	450/550
Drive and transmission control device							
Engine mode		KUBOTA WG2503		KUBOTA V2403-CR-TE5B		XINCHAI 3E22YG51	
Engine rated power	kw/rpm	GAS:42.8/2600, LPG:43.5/2600		42.6/2400		44.8/2400	
Engine rated torque	Nm/rpm	GAS:163/1800, LPG:173.7/1400		195.6/1500		210/1600-1800	
Cylinder number-Bore×stroke		4-88×102.4		4-87×102.4		3-94×107	
Engine displacement	L	2.491		2.434		2.23	
Engine type		GAS/LPG		Diesel		Diesel	
Emission		EU StageV / EPA/CARB Tier3		EU StageV / EPA/CARB Tier4		EU StageV	
Battery(Voltage/Capacity)	V/Ah	12/60		12/95		12/80	

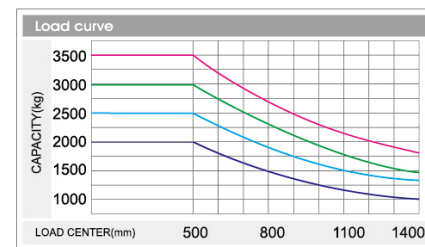
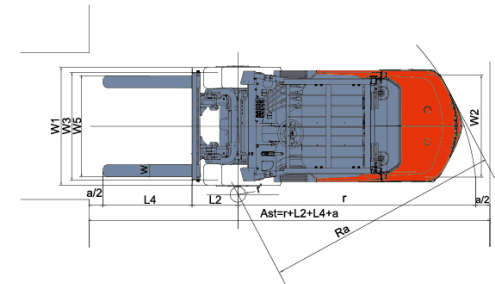
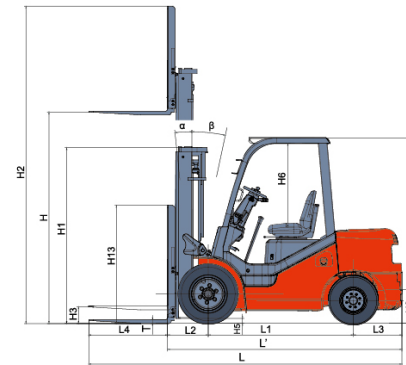

— CP(Q)YD20
— CPCD20
— CP(Q)YD30
— CPCD30
— CP(Q)YD25
— CPCD25
— CP(Q)YD35
— CPCD35



MEMO

WIDE VIEW MAST													
Mast model	Max. lifting height (mm)	Load capacity (load center 500mm)(Kg)				Mast overall height (fork to the ground) (mm)			Service weight (kg)				Mast tilting angle (°) α / β
		CP(Q)YD20/CPCD20	CP(Q)YD25/CPCD25	CP(Q)YD30/CPCD30	CP(Q)YD35/CPCD35	2-2.5t	3t	3.5t	CP(Q)YD20/CPCD20	CP(Q)YD25/CPCD25	CP(Q)YD30/CPCD30	CP(Q)YD35/CPCD35	
M200	2000	2000	2500	3000	3500	1459	1570	1680	3280	3650	4250	4610	6°-12°
M250	2500	2000	2500	3000	3500	1745	1820	1930	3330	3700	4300	4650	6°-12°
M300	3000	2000	2500	3000	3500	1995	2080	2180	3370	3740	4340	4700	6°-12°
M330	3300	2000	2500	3000	3500	2145	2220	2330	3400	3770	4360	4730	6°-12°
M350	3500	2000	2500	3000	3500	2245	2320	2430	3420	3790	4380	4750	6°-12°
M370	3700	2000	2500	3000	3500	2345	2420	2530	3430	3800	4400	4760	6°-12°
M400	4000	2000	2400	2900	3450	2545	2620	2730	3510	3880	4490	4840	6°-12°
M425	4250	2000	2250	2850	3400	2670	2745	2855	3530	3900	4510	4870	6°-12°
M450	4500	1950	2050	2750	3300	2795	2870	2980	3560	3930	4540	4900	6°-6°
M500	5000	1600	1650	2500	3000	3045	3120	3230	3600	3970	4580	4950	6°-6°
M550	5500	1200	1300	2100	2400	3345	3420	3530	3700	4070	4690	4990	3°-6°
M600	6000	800	950	1500	1700	3595	3670	3780	3740	4110	4730	5040	3°-6°

Note: (1) * Stands for the rated capacity when the front tyre is double-tyre. (2) When the front tyre of the 2-3.5t truck is double tyre, the service weight of the truck is the weight in the table plus 110kg.

WIDE VIEW FULL FREE 2-STAGE MAST																
Mast model	Max. lifting height (mm)	Load capacity (load center 500mm)(Kg)				Mast overall height (fork to the ground) (mm)			Free lift height (with backrest) (mm)			Service weight (kg)				Mast tilting angle (°) α / β
		CP(Q)YD20/CPCD20	CP(Q)YD25/CPCD25	CP(Q)YD30/CPCD30	CP(Q)YD35/CPCD35	2-2.5t	3t	3.5t	2-2.5t	3t	3.5t	CP(Q)YD20/CPCD20	CP(Q)YD25/CPCD25	CP(Q)YD30/CPCD30	CP(Q)YD35/CPCD35	
ZM200	2000	2000	2500	3000	3500	1459	1570	1680	495	340	460	3300	3670	4270	4660	6°-12°
ZM250	2500	2000	2500	3000	3500	1745	1820	1930	745	590	710	3360	3730	4310	4700	6°-12°
ZM300	3000	2000	2500	3000	3500	1995	2070	2180	995	840	960	3430	3800	4360	4750	6°-12°
ZM330	3300	2000	2500	3000	3500	2145	2220	2330	1145	990	1110	3470	3840	4390	4780	6°-12°
ZM350	3500	2000	2500	3000	3500	2245	2320	2430	1245	1090	1210	3500	3870	4410	4800	6°-12°
ZM370	3700	2000	2500	3000	3500	2345	2420	2530	1345	1190	1310	3520	3890	4430	4810	6°-12°
ZM400	4000	2000	2450	2950	3350	2545	2620	2730	1545	1390	1510	3610	3980	4500	4890	6°-12°
ZM425	4250	2000	2300	2900	3400	2670	2745	2855	1670	1515	1635	3650	4020	4530	4920	6°-6°
ZM450	4500	1950	2100	2800	3250	2795	2870	2980	1795	1640	1760	3680	4050	4550	4960	6°-6°
ZM500	5000	1600	1700	2500	3100	3045	3120	3230	2045	1890	2010	3750	4120	4600	5000	6°-6°
ZM550	5500	1200	1350	2100	2500	3345	3420	3530	2345	2190	1310	3860	4230	4690	5040	3°-6°
ZM600	6000	800	950	1500	1800	3595	3670	3780	2595	2440	2560	3930	4300	4740	5090	3°-6°

Note: (1) * Stands for the rated capacity when the front tyre is double tyre. (2) When the front tyre of the 2-3.5t truck is double tyre, the service weight of the truck is the weight in the table plus 110kg. (3) The free lifting height (without backrest) of the 2-2.5t truck is the height (with backrest) in the table plus 432mm. The free lifting height (without backrest) of the 3t truck is the height (with backrest) in the table plus 568mm. The free lifting height (without backrest) of the 3.5t truck is the height (with backrest) in the table plus 505mm.

WIDE VIEW FULL FREE 3-STAGE MAST																
Mast model	Max. lifting height (mm)	Load capacity (load center 500mm)(Kg)				Mast overall height (fork to the ground) (mm)			Free lift height (with backrest) (mm)			Service weight (kg)				Mast tilting angle (°) α / β
		CP(Q)YD20/CPCD20	CP(Q)YD25/CPCD25	CP(Q)YD30/CPCD30	CP(Q)YD35/CPCD35	2-2.5t	3t	3.5t	2-2.5t	3t	3.5t	CP(Q)YD20/CPCD20	CP(Q)YD25/CPCD25	CP(Q)YD30/CPCD30	CP(Q)YD35/CPCD35	
ZSM360	3600	2000	2500	3000	3200	1795	1930	1930	795	705	710	3520	3890	4510	4770	6°-6°
ZSM400	4000	2000	2500	3000	3200	1920	2055	2055	920	830	835	3550	3920	4540	4800	6°-6°
ZSM435	4350	1950	2250	2950	3200	2045	2180	2180	1045	955	960	3580	3950	4580	4840	6°-6°
ZSM450	4500	1900	2150	2900	3200	2095	2230	2230	1095	1005	1010	3600	3970	4590	4850	6°-6°
ZSM470	4700	1850	2000	2850	3200	2160	2230	2230	1160	1005	1010	3610	3980	4590	4850	6°-6°
ZSM480	4800	1850	1950	2700	3150	2195	2330	2330	1195	1105	1110	3620	3990	4620	4880	6°-6°
ZSM500	5000	1800	2300	2950	3200	2295	2430	2430	1295	1205	1210	3650	4020	4640	4910	6°-6°
ZSM540	5400	1450	1500	2250	2600	2420	2555	2555	1420	1330	1335	3680	4050	4680	4940	3°-6°
ZSM600	6000	850	1000	1550	1800	2645	2780	2780	1645	1555	1560	3780	4150	4780	5040	3°-6°

Note: (1) * Stands for the rated capacity when the front tyre is double-tyre. (2) When the front tyre of the 2-3.5t truck is double tyre, the service weight of the truck is the weight in the table plus 110kg. (3) The free lifting height (without backrest) of the 2 2 5t truck is the height (with backrest) in the table plus 445mm. The free lifting height (without backrest) of the 3 3 5t truck is the height (with backrest) in the table plus 554mm.